

27-1.3X-CL15

Deck Mounted 2 Hole Extended Spout Lavatory Set

Includes MPU7 pop-up drain

Flow Rate: 1.2 GPM

Note: Please specify up to 4" spout extension when ordering

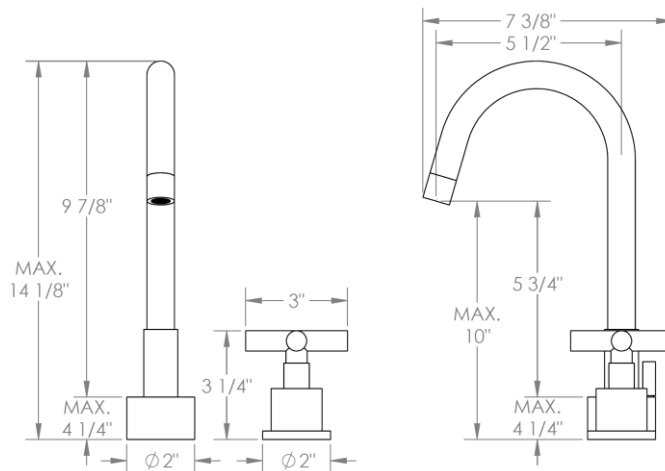

Meets the applicable requirements of ASME A112.18.1-2005/CSA B125.1-05, entitled "Plumbing Supply Fittings"

WATERMARK DESIGNS 1/21/2019

350 Dewitt Ave Brooklyn NY 11207 USA T 718 257 2800 F 718 257 2144 info@watermark-designs.com