

180-HSPB1-__

Positioning Bar Shower Kit with Hand Shower and 69" Hose

Flow Rate: 1.75 GPM

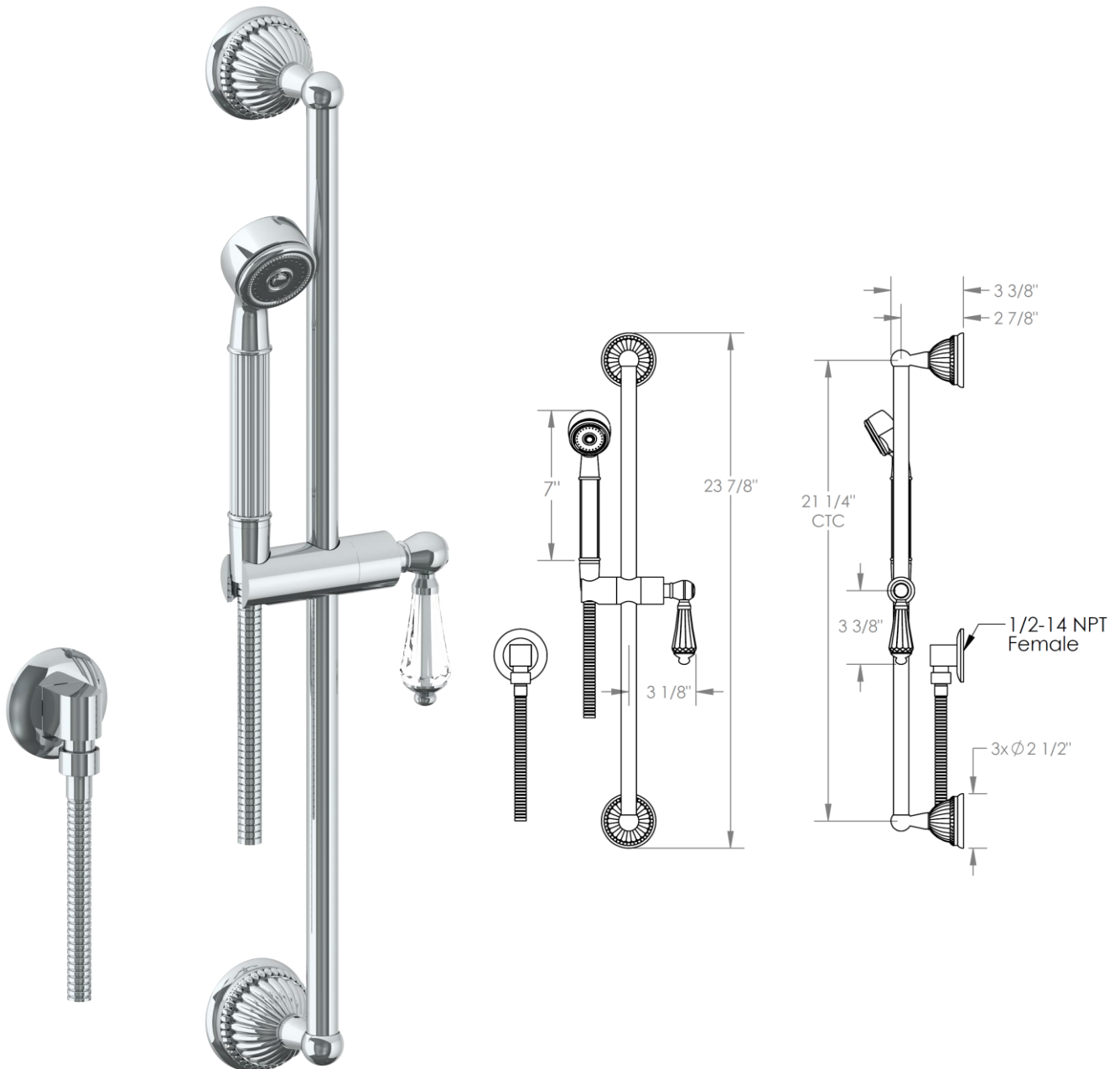

Meets the applicable requirements of ASME A112.18.1-2005/CSA B125.1-05, entitled "Plumbing Supply Fittings"

HANDLE TRIM OPTIONS

AA - VENICE
BB - GENOA

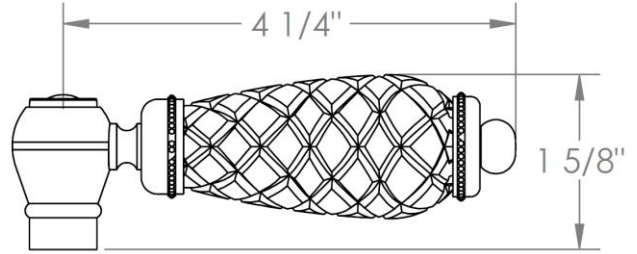

CC - POMPEI
DD - NAPLES

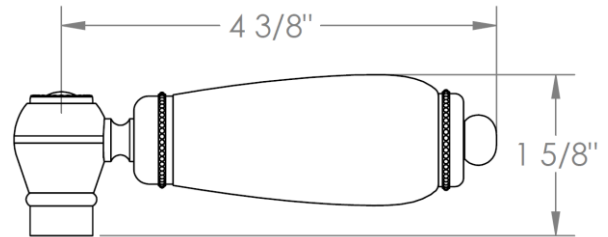
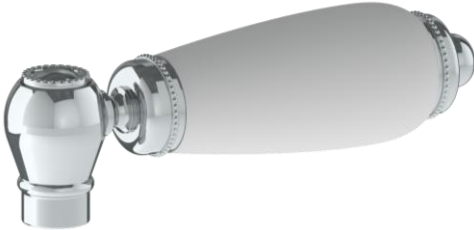

SWU - FLORENCE

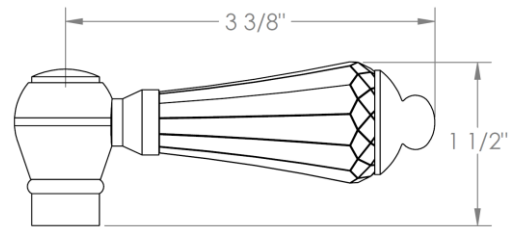

T - TUSCANY

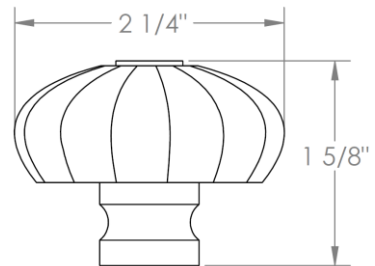

U - BOLOGNA

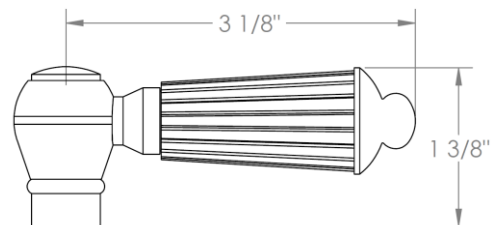

WATERMARK DESIGNS

10/15/2018