



Silestone® quartz 37" vanity top with rectangle cutout K-28250

Features

- Designed for use with compatible 36" (914 mm) KOHLER® vanities (sold separately).
- Available in many classic and warm neutral tones to work seamlessly in any decor.
- Pairs beautifully with select KOHLER® and Artist Editions® sinks for a complete solution.
- ½" (12.7 mm) countertop overhang per side.
- Flat, square edges give a crisp, finished look.
- Optional side and backsplashes available (sold separately).
- This product is covered under the Silestone® 25-Year Limited Warranty.



Material

- Silestone® quartz.
- Silestone® quartz.

Installation

- Vanity top.
- Single faucet hole with pilot holes for optional 8" (203 mm) widespread faucet configuration.

Recommended Products/Accessories

- K-2882 Undermount bathroom sink
- K-2330 Undermount bathroom sink
- K-20000 Undermount bathroom sink

Optional Products/Accessories

- K-28263 Silestone® quartz 37" backsplash
- K-28266 Silestone® quartz side splash

Included Components

- Additional Components:
Mounting Screws

Codes/Standards





None Applicable

KOHLER® One-Year Limited Warranty

See website for detailed warranty information.

Available Colors/Finishes

Color tiles intended for reference only.

Color	Code	Description
	ESR	ET Serena
	EMQ	ET Marquina
	EST	ET Statuario
	MMW	Miami White
	IBZ	



Silestone® quartz 37" vanity top with rectangle cutout
K-28250

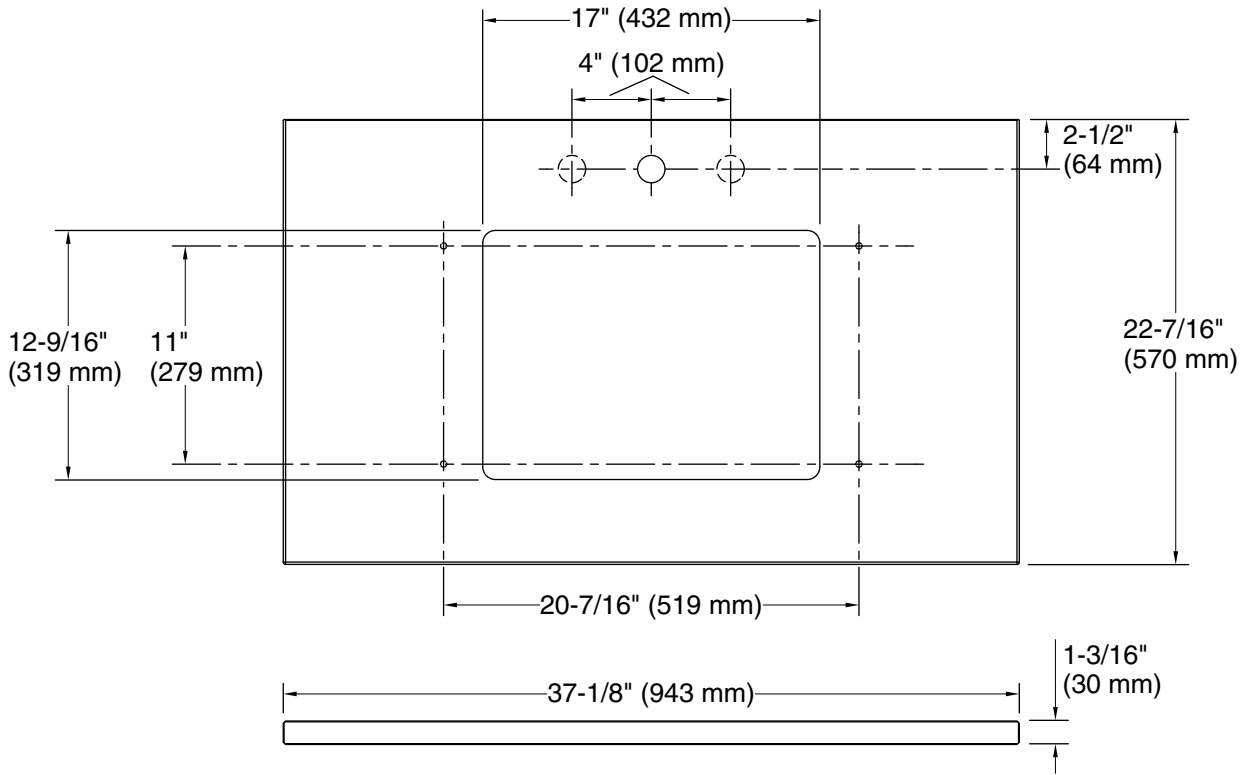

Technical Information

All product dimensions are nominal.

Installation: Vanity top/ITB

Number of deck holes: 1

Notes

Install this product according to the installation instructions.