

Features

- Bask® heated surface creates spa-like relaxation with soothing warmth on your back and neck.
- Three heat settings allow you to customize the surface temperature.
- Single-speed whirlpool offers performance and value, with 8 fully adjustable jets.
- Hydromassage flow and direction can be controlled at each jet.
- Comfort Depth® design offers a convenient 19-inch step-over height while retaining the same depth as a standard 21-inch bath.
- Generous 6-foot length provides an incredibly spacious bathing area.
- Molded lumbar support and armrests offer extra comfort while bathing.
- Slotted overflow allows for deep soaking.
- Integral apron.
- Integral flange helps prevent water from seeping behind wall and simplifies alcove installation.
- Textured bottom surface
- Left-hand drain.
- Coordinates with other products in the Archer collection.

Material

- Acrylic

Hydrotherapy

- Whirlpool

Installation

- Three-wall alcove.

Additional Hydrotherapy Options

- Soaking Bath - K-1125-LA
- Soaking Bath + Bask heated surface - K-1125-LAW
- BubbleMassage air bath - K-1124-GLA
- BubbleMassage air bath + Bask heated surface - K-1124-GLAW
- VibrAcoustic - K-1124-VBLA
- VibrAcoustic + Bask heated surface - K-1124-VBLAW
- Whirlpool - K-1124-LA
- Whirlpool + heater - K-1124-HL
- Whirlpool + Bask heated surface - K-1124-LAW
- Whirlpool + BubbleMassage air bath - K-1124-XHGLA

Required Products/Accessories

K-7271 Brass Slotted Overflow Bath Drain

or

K-7272 PVC Slotted Overflow Bath Drain



ADA

Codes/Standards











ASME A112.19.7/CSA B45.10
CSA B45.5/IAPMO Z124
ASTM E162
ASTM E662
UL 1795
ADA
ICC/ANSI A117.1

**KOHLER® Plastic Baths and Receptors
Lifetime Limited Warranty
KOHLER® Hydrotherapy Components
Five-Year Limited Warranty**

See website for detailed warranty information.

Available Colors/Finishes

Color tiles intended for reference only.

Color	Code	Description
	0	White
	96	Biscuit
	47	Almond
	NY	Dune
	95	Ice™ Grey
	G9	Sandbar
	33	Mexican Sand™
	K4	Cashmere
	58	Thunder™ Grey
	7	Black Black™

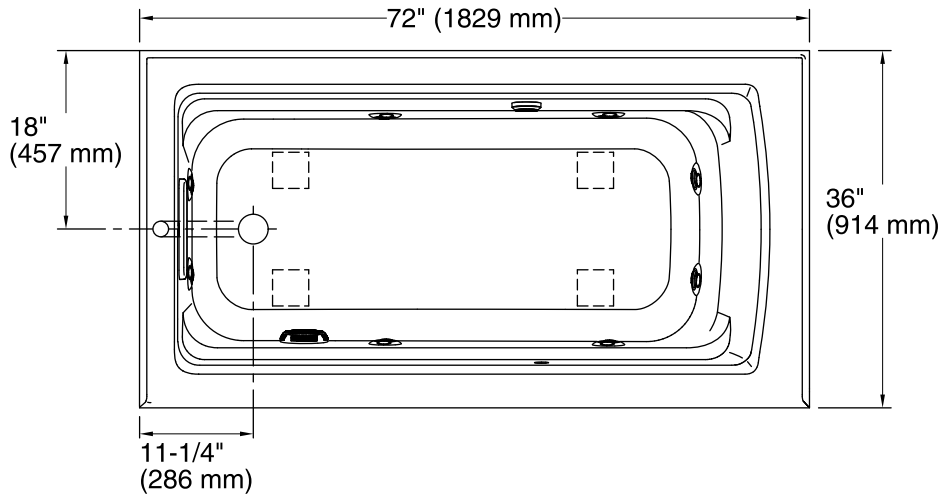

No change in measurements if connected with drain illustrated. (K-7272)

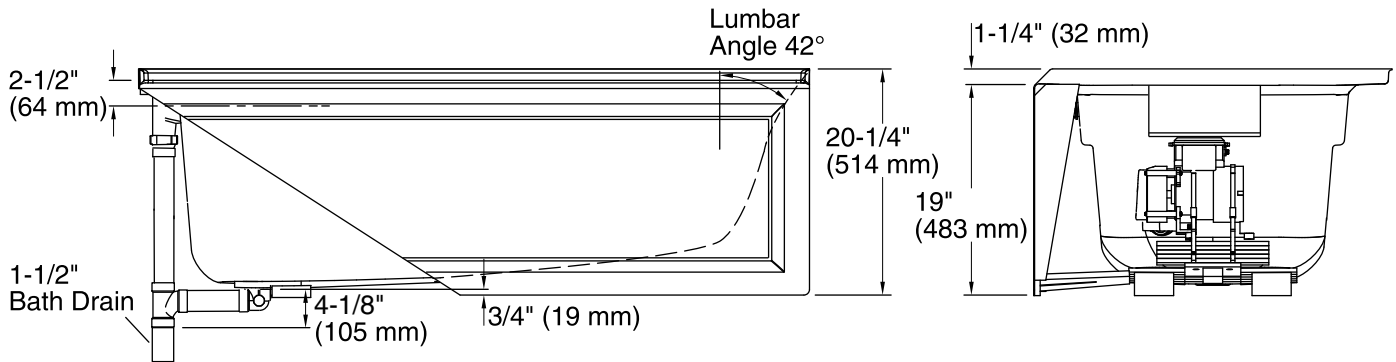
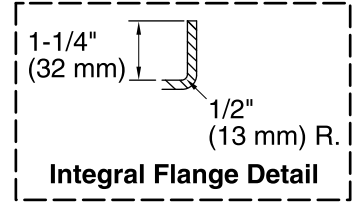

Required Electrical Service

One dedicated circuit required, protected with Class A Ground-Fault Circuit-Interrupter (GFCI). Outside North America, this device may be known as a Residual Current Device (RCD).

Pump, Heated 120 V, 15 A, 60 Hz
 Surface:

Technical Information

All product dimensions are nominal.

- Installation: Three-wall alcove
- Drain location: Left
- Basin area, bottom: 51-3/8" x 21" (1305 mm x 533 mm)
- Basin area, top: 64-1/2" x 30-1/2" (1638 mm x 775 mm)
- Weight: 141 lbs (64 kg)
- Minimum floor load: 43 lbs/ft² (209.9 kg/m²)
- Water depth: 15" (381 mm)
- Water capacity: 72 gal (272.5 L)
- Electrical component rating: Pump: 120 V, 7 A, 60 Hz
 Heated Surface: 120 V, 0.5 A, 60 Hz
- Pump speed: Single
- Minimum flat for door: 1-9/16" (40 mm)

Notes

- Measure your actual product for rough-in details. Install this product according to the installation instructions.
- The hot water supply should be 70% of the capacity of the bath or greater. Installations will vary.
- ADA compliant when installed to the specific requirements of these regulations.